



**reflex**

**News**

IMM Cologne 2019



- 4 TAVOLO OH ALLUNGABILE  
*OH TABLE EXTENDABLE*
- 6 TAVOLO OH FISSO  
*OH TABLE FIX*
- 8 TAVOLO SIGNORE DEGLI ANELLI 72 STEEL  
*SIGNORE DEGLI ANELLI 72 STEEL TABLE*
- 10 BUFFET VERTIGO  
*VERTIGO BUFFET*
- 12 SEDIA AMET  
*AMET CHAIR*
- 14 CONSOLLE OH  
*OH CONSOLLE*
- 15 SPECCHIO SHELF  
*SHELF MIRROR*
- 16 LAMPADA ACCADEMIA  
*ACCADEMIA LAMP*

# TAVOLO OH Allungabile OH TABLE Extendable

Design - TULCZINSKY



**Meccanismo allungabile®** brevettato Reflex  
Reflex patent **extendable mechanism®**

Con il tavolo OH si continua l'ampliamento della collezione OH presentata al salone del mobile 2018. Un tavolo che trae spunto dal trapezio geometrico con linee semplici dal profilo minimale. Il basamento è realizzato in ferro piegato e saldato, disponibile nelle finiture metalliche Reflex. Il tavolo OH può essere fisso e allungabile. Il sistema di allunghe brevettato Reflex presenta un meccanismo monodirezionale innovativo che permette con un solo movimento di allungare il piano attraverso un'unica allunga. Il piano è disponibile in vetro marmo.

*The OH dining table continues the OH collection presented at the Salone del Mobile 2018. A table inspired by the geometric trapezium with simple lines with a minimal profile. The base is made of bent and welded iron, available in the Reflex satin metallic finishes. The OH table can be fixed or extendable. The Reflex patented extension system features an innovative unidirectional mechanism that allows with a single movement to extend the top through a single wing. The top is available in Marble glass.*



PIANO / TOP



Vetro Marmo / Marble glass  
sp./thick 10+4 mm  
FILO WING



Calacatta Calacatta oro Onice bianco Onice oro Onice verde Marmo di Cesare

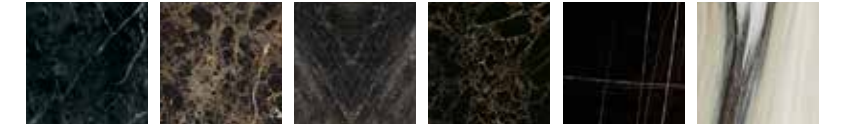

Grigio Carnico Emperador dark Grey Saint Laurent Orange black Sahara Zebrino



Vetro Colorato / Colored glass  
sp./thick 10+4 mm  
FILO WING

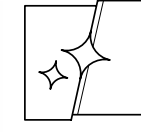

Vetro verniciato lucido / Shiny Laquered glass

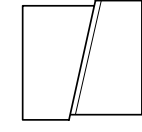

Vetro verniciato acidato / Etched laquered glass

MATERIAL SHEET D

BASAMENTO / BASE

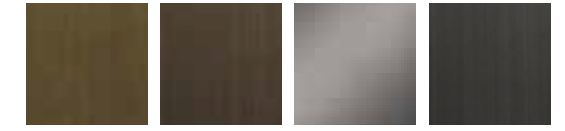

Ottone / Brass Ottone Dark / Dark Brass Titanium / Titanium Titanium Dark / Dark Titanium

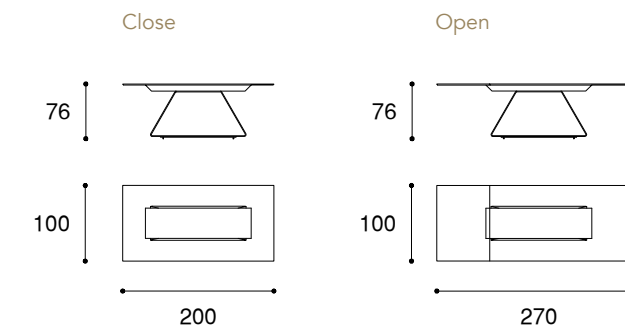

**TAVOLO OH Fisso**  
**OH TABLE Fix**  
 Design - TULCZINSKY

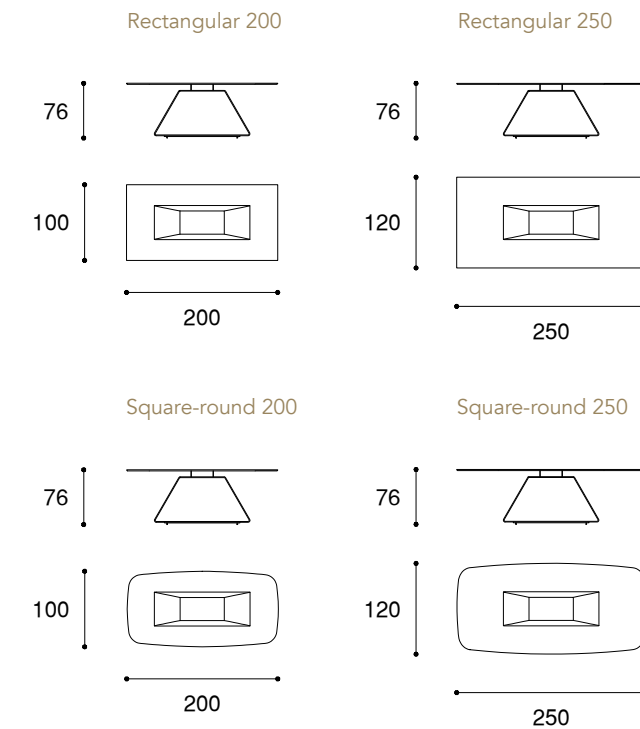

**PIANO / TOP** 1

Vetro Marmo / Marble glass sp./thick 10+4 mm FILO WING

Calacatta	Calacatta oro	Onice bianco	Onice oro	Onice verde	Marmo di Cesare
Grigio Carnico	Emperador dark	Grey Saint Laurent	Orange black	Sahara	Zebrino

Vetro Colorato / Colored glass sp./thick 10+4 mm FILO WING

Vetro verniciato lucido / Shiny Laquered glass	Vetro verniciato acidato / Etched laquered glass	Vetro fumè / Smoked glass

Vetro / Glass sp./thick 15 mm FILO LUCIDO

Vetro trasparente / Transparent glass

Bevel wood legno / Bevel wood sp./thick 40 mm

Rovere Henné / Oakwood Henné	Rovere Miele / Oakwood Miele	Noce Canaletto / Canaletto walnut

**BASAMENTO / BASE** 2

Ottone / Brass	Ottone Dark / Dark Brass	Titanium / Titanium	Titanium Dark / Dark Titanium

MATERIAL SHEET D

**TAVOLO SIGNORE DEGLI ANELLI 72 STEEL**  
*SIGNORE DEGLI ANELLI 72 STEEL TABLE*









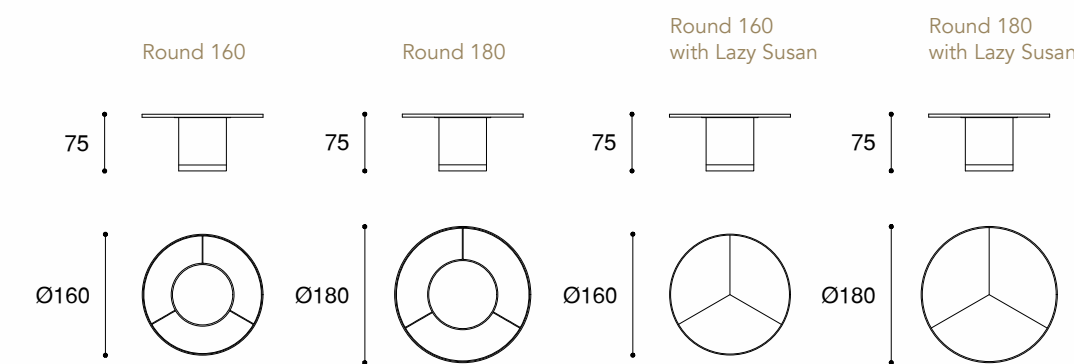





Design - R&C REFLEX

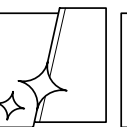
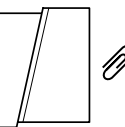

Il tavolo Signore degli Anelli 72 si completa con l'introduzione di una cover dal forte impatto stilistico che riveste la gamba centrale del basamento. Un tavolo funzionale ed estetico allo stesso tempo, di forte presenza scenica, che esprime attraverso il piano in vetromarmo e la trapuntatura Emerald un valore di estetica superiore.

*Signore degli Anelli 72 table is completed with the introduction of a cover for the base leg with a strong stylistic impact. A functional and at same time aesthetic table, with a strong stage presence, which expresses a value of superior aesthetics through the Marble glass top and the Emerald quilting.*



 Legno / Wood sp./thick 40 mm	<b>1</b> PIANO / TOP	<b>BORDO / RING</b>  Ottone / Brass  Ottone Dark / Dark Brass  Titanium / Titanium  Titanium Dark / Dark Titanium
	<b>2</b> INSERTO / INSERT	 Vetro Marmo / Marble glass  Vetro verniciato / laquered glass  Vetro verniciato acidato / Etched laquered glass MATERIAL SHEET D
<b>3</b> ACCESSORIO / OPTIONAL	 Pelle / leather: CAT C. Colorata Nabuk Naturale MATERIAL SHEET B  Trapunta San marco  Trapunta Diamond  Trapunta Emerald	
<b>4</b> GAMBA / LEG	 Ottone / Brass  Ottone Dark / Dark Brass  Titanium / Titanium  Titanium Dark / Dark Titanium	

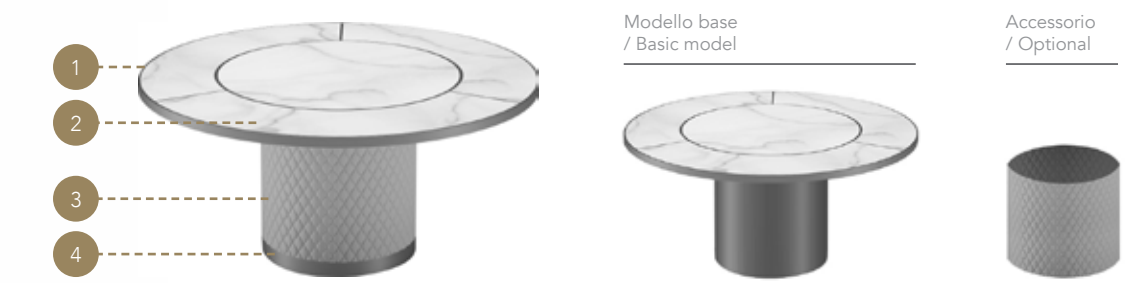



# BUFFET VERTIGO VERTIGO BUFFET

Design - RICCARDO LUCATELLO







Vertigo è il nuovo buffet Reflex che si caratterizza per leggerezza delle forme con un tratto tipico dell'innovazione Reflex dato dalle ante in vetro marmo. Sospeso, tramite un basamento in metallo dal forte carattere stilistico, presenta una struttura con vano a giorno e un meccanismo di scorrimento delle ante. L'attenzione ai dettagli è presente nella particolare raggiatura delle ante in vetromarmo che conferiscono dinamicità e leggerezza al design generale di Vertigo. La struttura e il vano a giorno sono disponibili in tutte le finiture dei legni, dei metalli e dei laccati. Lo schienale è rivestito in vetro fumè a specchio. Le ante sono disponibili in tutte le finiture del vetro marmo.

Vertigo is the new Reflex sideboard, characterized by light shapes with a typical Reflex innovation feature given by the Marble glass doors. Suspended, through metal legs with a strong stylistic character, has a structure with an open compartment and a sliding mechanism for the doors. The particular radius of the Marble glass doors underlines the attention to details and gives dynamism and lightness to the general design of Vertigo. The wooden structure and the open compartment are available in the satin metallic finishes, lacquered finish or in wood veneer. The back is covered in smoked mirror glass and the doors are available in all the finishes of the Marble glass.

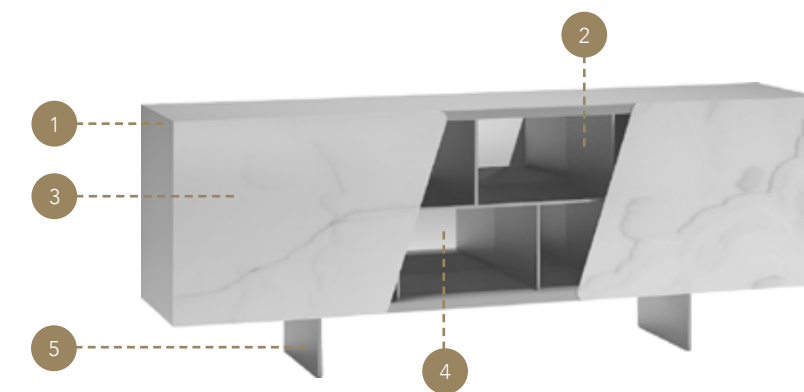
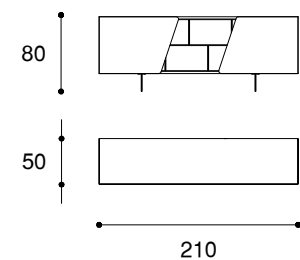

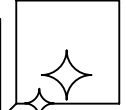
SCORRIMENTO ANTE / SLIDING DOORS

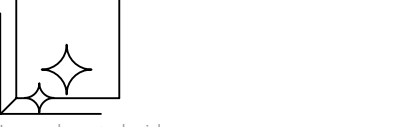

- 1**  
**STRUTTURA / STRUCTURE**  
  
 Legno laccato lucido / Shiny lacquered wood  
 MATERIAL SHEET C
- 2**  
**VANO A GIORNO / OPEN SECTION**  
  
 Ottone / Brass    Ottone Dark / Dark Brass    Titanium / Titanium    Titanium Dark / Dark Titanium
- 3**  
**ANTE / DOORS**  
  
 Legno laccato lucido / Shiny lacquered wood  
 Vetro Marmo / Marble glass    Vetro verniciato / laquered glass    Vetro verniciato acidato / Etched laquered glass  
 MATERIAL SHEET D
- 4**  
**SCHIENALE INTERNO / INTERNAL BACK**  
  
 Pelle / leather: CAT C. Colorata Nabuk Naturale  
 MATERIAL SHEET B
- 5**  
**PIEDINI / LEGS**  
  
 Ottone / Brass    Titanium / Titanium

# SEDIA AMET AMET CHAIR

Design - EMANUELE MISSAGLIA



Modello con cover trapuntata  
/ Model with quilted cover

La semplicità e leggerezza delle forme vengono rafforzate e messe in risalto dalla cover esterna che è il tratto saliente della sedia Amet. Una cover che può essere personalizzabile e disponibile secondo le esigenze di progetto.

La sedia presenta una seduta e uno schienale imbottiti a quote differenziate per migliorare il comfort soggettivo e oggettivo del fruitore.

Le gambe in legno di frassino sono disponibili nelle finiture metalliche, nei laccati e nei legni tinti.

*The salient features of the Amet chair are simplicity and lightness of the shapes, strengthened and highlighted by the external cover, which can be customized according to the project needs.*

*The chair has padded seat and back with different density layers to improve the subjective and objective comfort of the user.*

*The ash wood legs are available in the satin metallic finishes, lacquered or in stained wood finishes.*

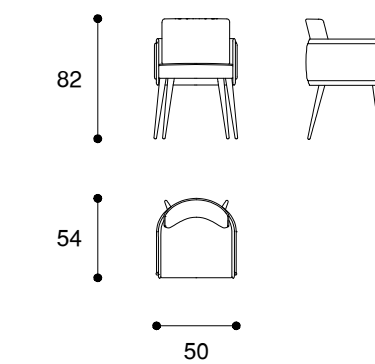

Modello con cover  
/ Model with cover



Modello base  
/ Basic model

**1** SCHIENALE, SEDUTA e STRUTURA / BACK, SEAT and STRUCTURE

Pelle / leather: CAT C. Colorata Nabuk Naturale

Tessuto / Fabric: Super Extra Luxury

Velluto / Velvet

MATERIAL SHEET B

MATERIAL SHEET A

**2** COVER ESTERNA / EXTERNAL COVER

Pelle / leather: CAT C. Colorata Nabuk Naturale

Tessuto / Fabric: Super Extra Luxury

Velluto / Velvet

MATERIAL SHEET B

MATERIAL SHEET A

Trapunta San marco    Trapunta Diamond    Trapunta Emerald

**3** GAMBE / LEGS

Ottone / Brass    Ottone Dark / Dark Brass    Titanium / Titanium    Titanium Dark / Dark Titanium

Legno laccato lucido / Shiny lacquered wood

Rovere Beluga / Oakwood Beluga

MATERIAL SHEET C

Modello base / Basic model    Cover esterna / External cover

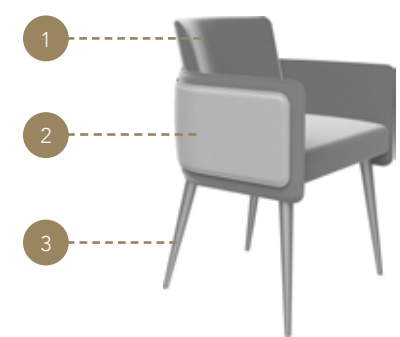

## CONSOLE OH OH CONSOLE

Design - TULCZINSKY



Con la console OH continua il processo di innovazione e tecnologia di Reflex.  
Una linea di estremo rigore che si ferma e rimane sospesa nell'aria, su cui poi si appoggia un piano a sbalzo. Uno stile Reflex che si proietta verso il dinamismo e fluidità del mondo automobilistico. Il basamento è realizzato in ferro piegato e saldato, disponibile nelle finiture metalliche Reflex. Il piano è disponibile in vetro trasparente e in vetro marmo.

*The Reflex innovation and technology process continues with the OH console.  
A line of extreme rigor that stops and remains suspended in the air and supports a cantilevered top.  
A Reflex style that projects itself towards the dynamism and fluidity of the automotive world.  
The base is made of bent and welded iron, available in the Reflex satin metallic finishes.  
The top is available in clear or smoked glass and in Marble glass.*

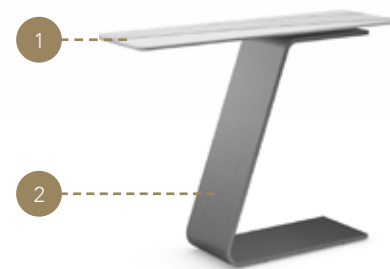
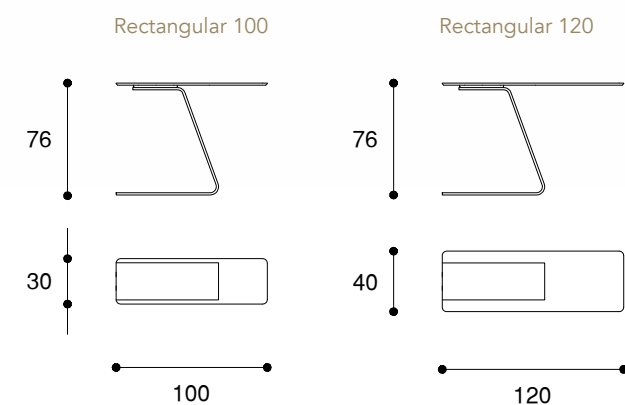

PIANO  
/ TOP 1



Vetro Marmo / Marble glass  
sp./thick 10+4 mm  
Angoli arrotondati / Round corner 30mm  
FILO WING



Calacatta Calacatta oro Onice bianco Onice oro



Onice verde Marmo di Cesare Grigio Carnico Emperador dark



Grey Saint Laurent Orange black Sahara Zebrino



Vetro / Glass  
sp./thick 10 mm  
Bisello / Bevel 45°  
Angoli arrotondati / Round corner 30mm



Vetro trasparente / Transparent glass Vetro fumè / Smoked glass

BASAMENTO  
/ BASE 2



Ottone / Brass Ottone Dark / Dark Brass Titanium / Titanium Titanium Dark / Dark Titanium

## SPECCHIO SHELF SHELF MIRROR

Design - TULCZINSKY

Una linea di specchi con una doppia funzione, non solo specchio, non solo mensola, ma entrambe. Un prodotto, che riprende il disegno essenziale e pulito dello stile Disegno di Reflex, adatto per diversi ambienti e che si esprime al meglio come piccolo maggiordomo per appoggiare piccoli oggetti che si riflettono nello specchio; un prodotto che completa e arricchisce gli ambienti di vita quotidiana non solo con stile ma anche curando la funzione.

*A collection of mirrors with a double function, not just a mirror, not just a shelf, but both.  
A product, which incorporates the essential and clean design of the Reflex Disegno style, suitable for different spaces, best expressed as a small butler to support small objects that are reflected in the mirror; a product that completes and enriches the spaces of daily life, not only with style but also taking care of the function.*

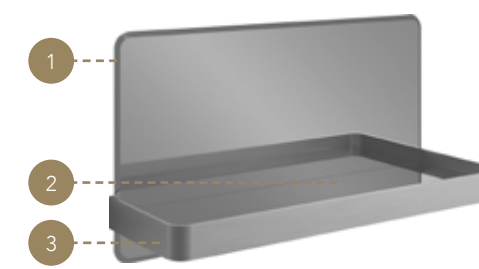
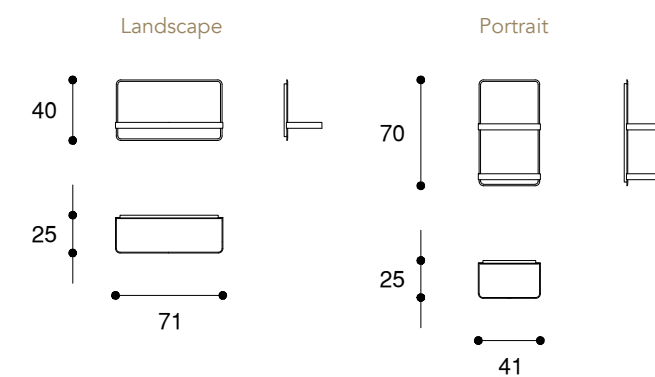

1		Specchio bronzo / Bronze mirror
SPECCHIO / MIRROR		
2		Vetro trasparente / Transparent glass
MENSOLA INTERNA / INTERNAL SHELF		
3		Ottone / Brass
		Ottone Dark / Dark Brass
MENSOLA ESTERNA / EXTERNAL SHELF		
		Titanium / Titanium
		Titanium Dark / Dark Titanium



## LAMPADA ACCADEMIA ACCADEMIA LAMP

Design - TULCZINSKY

La collezione Accademia nata con i tavolini si arricchisce con le lampade a sospensione e da tavolo, qui presentate nella finitura in rame.

Due dimensioni per creare dinamicità e ritmo, due funzioni sia come lampade da appoggio sia come lampade a sospensione.

Un nuovo prodotto di design, luminoso, dal forte impatto decorativo in pieno stile Reflex, di tradizione veneziana.

*The Accademia collection, born with the tables, is enriched with pendant and table lamps, presented here in the copper finish.*

*Two dimensions to create dynamism and rhythm, two functions both as table lamps and as pendant lamps.*

*A new design product, bright, with a strong decorative impact in full Reflex style, of Venetian tradition.*



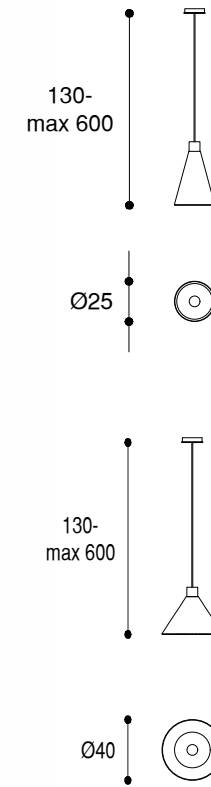

Lampada a sospensione  
/ Suspended lamp

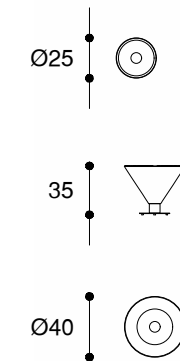

47  
Lampada da tavolo  
/ Table lamp



1  
PARALUME  
/ SHADE

		Vetro di Murano
ARGENTO	BRONZO	
		
RAME	ORO	

2  
BASAMENTO  
/ BASE

			
Ottone / Brass	Ottone Dark / Dark Brass	Titanium / Titanium	Titanium Dark / Dark Titanium



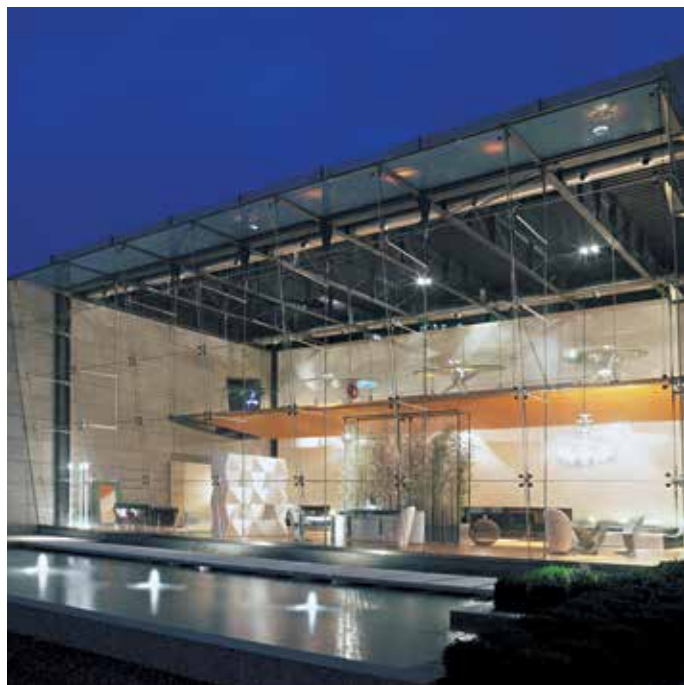

#### SHOWROOM BIANCADE

Via Gabriele D'Annunzio, 77  
31056 Biancade  
Treviso – Italy  
(+39) 0422 849201



#### SHOWROOM MILANO

Via Madonnina, 17  
20121 Brera  
Milano – Italy  
(+39) 02 80582955



#### SHOWROOM BERLINO

Taubenstrasse, 26  
D-10117 Berlino  
Germania  
(+49) (0)30 20 888 705  
berlin@reflexangelo.com



[www.reflexangelo.com](http://www.reflexangelo.com)

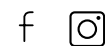

#### REFLEX SPA

Via Paris Bordone 78/80  
31056 Biancade (TV)  
T +39 0422 844440  
T estero +39 0422 844430  
F + 39 0422 849765  
E info@reflex@reflexangelo.com

Nessuna parte di questo documento, testo o fotografia può essere riprodotta o trasmessa in qualsiasi forma o tramite mezzo elettronico o meccanico, comprese le fotocopie, senza previo permesso scritto da parte della società REFLEXANGELO.  
No part of this document, text or photo may be reproduced or transmitted in any shape or form, through electronic or paper-based communication, including photocopies, without the prior express written consent of REFLEXANGELO.  
I colori dei legni, delle laccature, dei tessuti e delle pelli presenti in questo catalogo sono suscettibili dei procedimenti di stampa. Fa fede il campionario dell'azienda. REFLEXANGELO si riserva la facoltà di modificare in qualunque momento e senza preavviso le caratteristiche tecniche (misure, finiture, tessuti e pelli) dei suoi prodotti.  
Wood, lacquer, fabric and leather colours are not binding and may vary due to printing. Please refer to the company sets of samples. REFLEXANGELO reserves the right to modify the technical specifications of the products (sizes, finishes, leather and fabrics) featured in this catalogue at any time and without prior notice.

