

FD01
Left End
W800
D875
H750/900/1100 mm

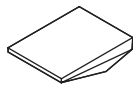

FD02S
Left End Cantilever
W1200
D875
H750 mm

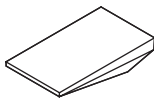

FD02M
Left End Cantilever
W1600
D875
H750 mm

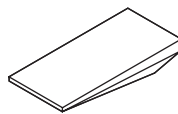

FD02L
Left End Cantilever
W2000
D875
H750 mm

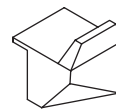

FD03
Left Cantilever
W800
D875
H750/900/1100 mm

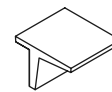

FD04
Straight Cantilever
W800
D875
H750 mm

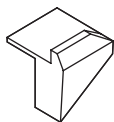

FD05
Right Cantilever
W800
D875
H750/900/1100 mm

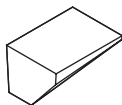

FD06S
Right End Cantilever
W1200
D875
H750 mm

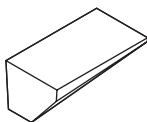

FD06M
Right End Cantilever
W1600
D875
H750 mm

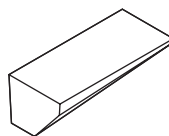

FD06L
Right End Cantilever
W2000
D875
H750 mm

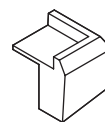

FD07
Right End
W800
D875
H750/900/1100 mm

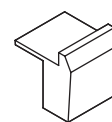

FD08
Straight
W800
D875
H750/900/1100 mm

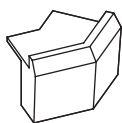

FD09
Angle 45
W1366/1185
D875
H750/900/1100 mm

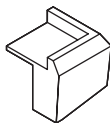

FD10
Angle 90
W875
D875
H750/900/1100 mm

Dimensions relate to the footprint of the product at:
750mm height = no upstand
900mm height = 150mm upstand
1100mm height = 350mm upstand

Website: www.isomi.com
Email: info@isomi.com

North West Office: +44 (0)161 903 9797
London Showoom: +44 (0)20 7388 8599

Fold Desk Configurations

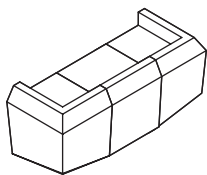

1
W2400
D875
H750/900/1100 mm

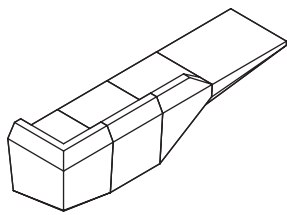

2
W3600
D875
H750/900/1100 mm

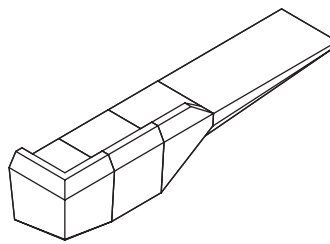

3
W4400
D875
H750/900/1100 mm

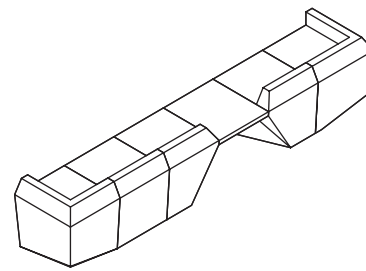

4
W4800
D875
H750/900/1100 mm

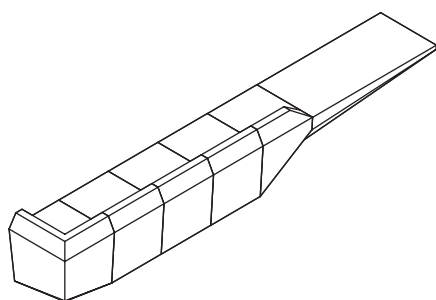

5
W6000
D875
H750/900/1100 mm

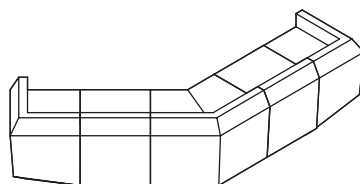

6
W4098/2316
D875
H750/900/1100 mm

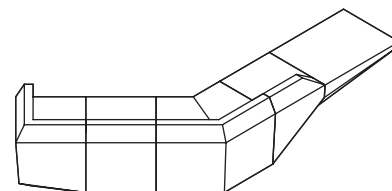

7
W4380/2599
D875
H750/900/1100 mm

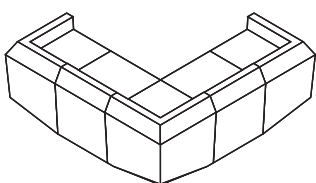

8
W2475/2475
D875
H750/900/1100 mm

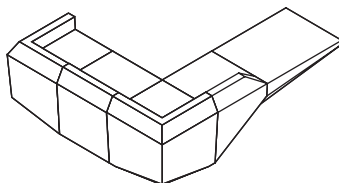

9
W2475/2875
D875
H750/900/1100 mm

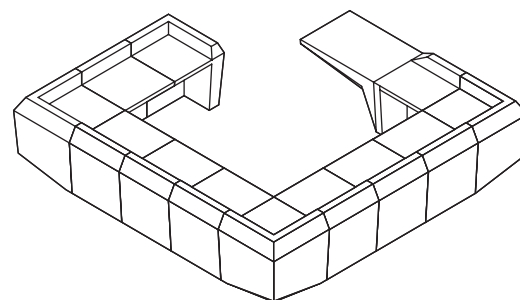

10
W4150/4150
D875
H750/900/1100 mm

Dimensions relate to the footprint of the product at:
750mm height = no upstand
900mm height = 150mm upstand
1100mm height = 350mm upstand

Website: www.isomi.com
Email: info@isomi.com

North West Office: +44 (0)161 903 9797
London Showoom: +44 (0)20 7388 8599

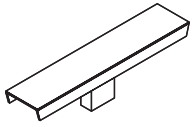

Fold
Sign-in platform
Translucent smoked glass
W1435
D300
H350 mm



TB
Translucent branding
W800
H200 mm

(recommended dimensions)

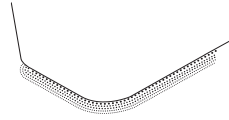

LS
LED skirting

Translucent branding can be customised to any required size.

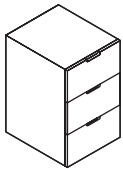

DU
Drawer unit
W400
D250/525
H670 mm

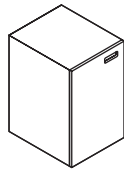

CU
Cupboard unit
W400
D250/525
H670 mm

Soft close is unavailable for drawer units at 250mm depth.