

# mdf italia



© COPYRIGHT 2020 MDF ITALIA SRL SOCIETA' UNIPERSONALE

2017-2019

## 20.VENTI

Designed by 967ARCH

This office system 20.VENTI features a linear iconic design typical of MDF Italia's "dna".

A reflection on the desk, the archetypal workstation, proposes to create an office atmosphere in a contemporary key. The contrast between full and empty volumes, the carefully studied combination of various finishes and the cables built into the bearing frame define a renewed proposal for office furnishings.

The technical challenge starts from the use of a slender frame generated by a 20x20 profile, a feature that perfectly merges with MDF Italia's other table and storage collections.

The collection 20.VENTI includes both individual tables and double workstations, which can be aggregated, and a wide selection of screens and accessories.

Designed by 967Arch for MDF Italia to offer an extensive choice of dimensions and finishes for working areas, management offices and residential settings where tables for nomadic technological work are becoming a common trait.

NOVELTIES 2019

Further to the single desk and workstation two users, a new workstation four users and a flex workstation for shared working space - with customizable dimensions according to the needs - have been integrated into the collection. In addition, the new 110 cm high workstation has also been integrated: an ideal solution for quick and standing meetings, to be held in shared and less formal spaces than meeting rooms.

20.VENTI SELECTED FOR COMPASSO D'ORO ADI 2020

[DOWNLOAD THE CATALOGUE](#)

## TOPS

Tops are made of medium density fibreboard panels covered with Fenix NTM laminate in the matt colours white, light grey, medium grey and black that slide on linear self-lubricating guides.

Fenix NTM top in the colours light grey and medium grey certified in compliance with standard UNI EN13772 and UNI EN 13721.

Every workstation has a structural wireway that can be accessed by sliding the top. It can be used for electrification and cables, or simply as a small storage compartment for daily usage.

## FRAME

Steel frame and legs, section 20x20mm, painted with epoxy powder in the matt colours white and graphite grey.

Structural wireway made of medium density fibreboard two-tone surfaced panels, thickness 2cm, with the outside in matt colours white or graphite grey, and the inside always in medium grey.

## ACCESSORY WORKSTATION ELEMENTS

Open compartment, sound-absorption screen, pc stand with castors, wireway sleeve, stationary and document holder.

Available by project, partition with steel cables and two accessories for the structural wireway: the valet tray shelf and laptop or tablet bag.

**SINGLE DESK**

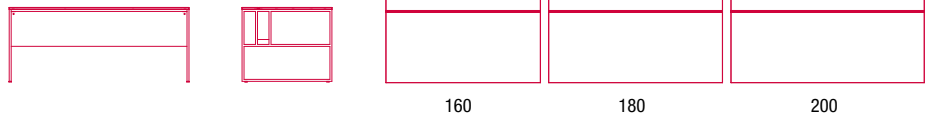
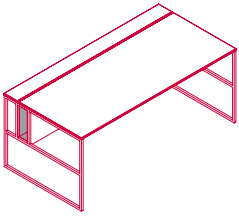

L160 D90 H75  
L180 D90 H75  
L200 D90 H75

**WORKSTATION TWO USERS**

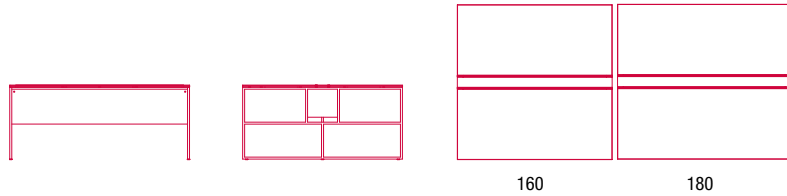
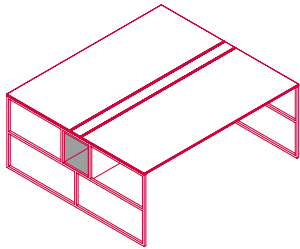

L160 D160 H75  
L180 D160 H75

**WORKSTATION FOUR USERS**

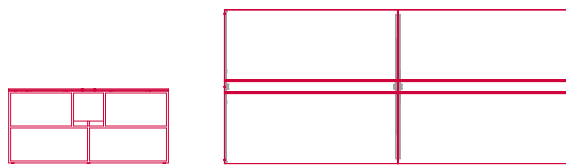
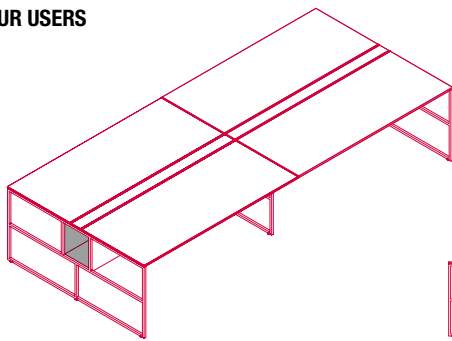

L320 D160 H75  
L360 D160 H75

**WORKSTATION FLEX**

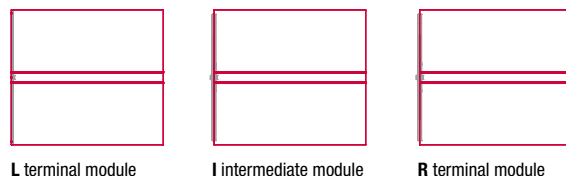
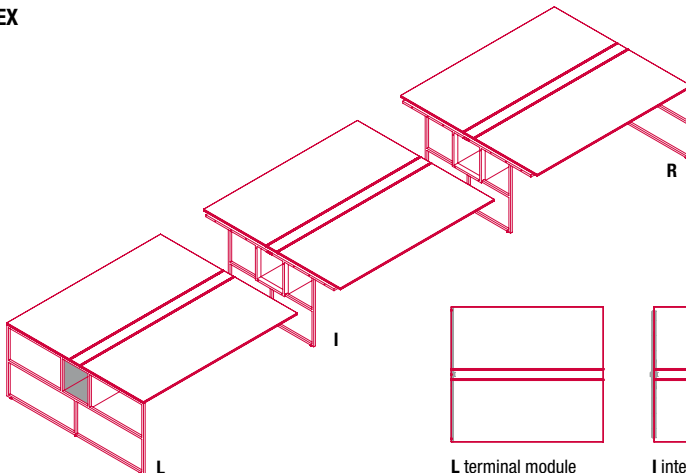

L160 D160 H75  
L180 D160 H75

## 20.VENTI



### HIGH WORKSTATION

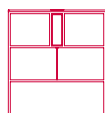
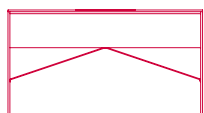
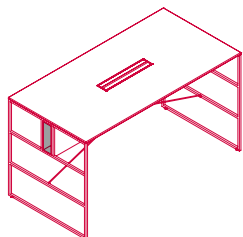

160



180



200

L160 D100 H110  
L180 D100 H110  
L200 D100 H110

### 20.VENTI HOME

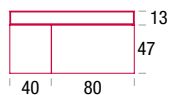
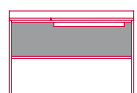
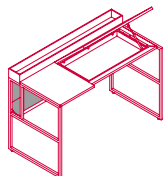
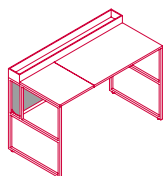

L120 D60 H75 / 81.5

**SINGLE DESK FRAME**

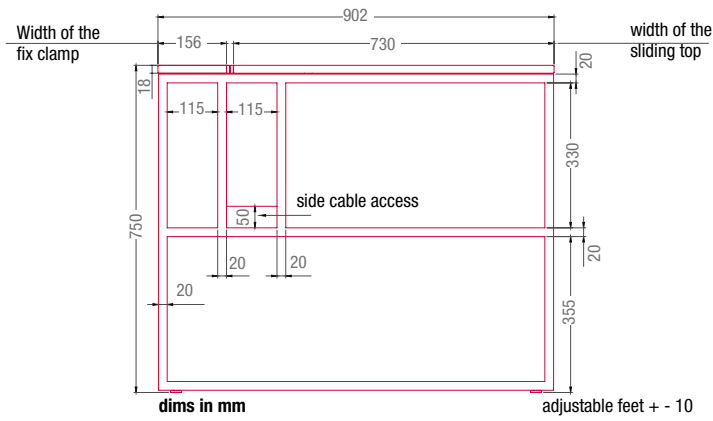

**SINGLE DESK SLIDING TOP**

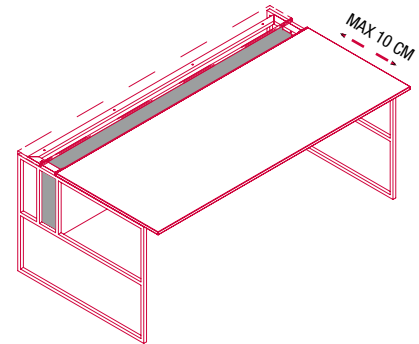

**DESKS WITH FRONT SEATS FRAME**

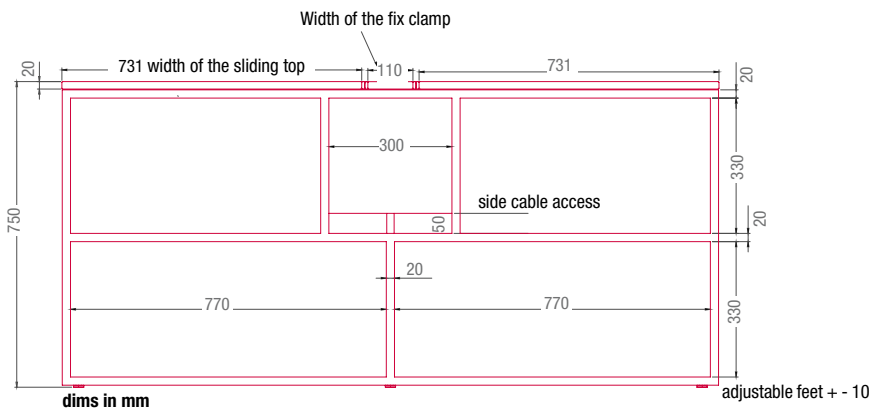

**DESKS WITH FRONT SLIDING TOP**

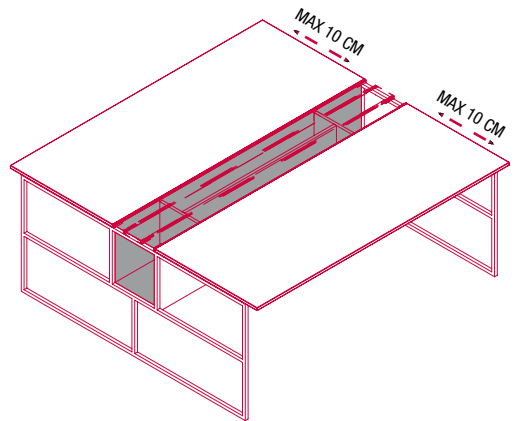

**HIGH TABLE BAR/OFFICE**

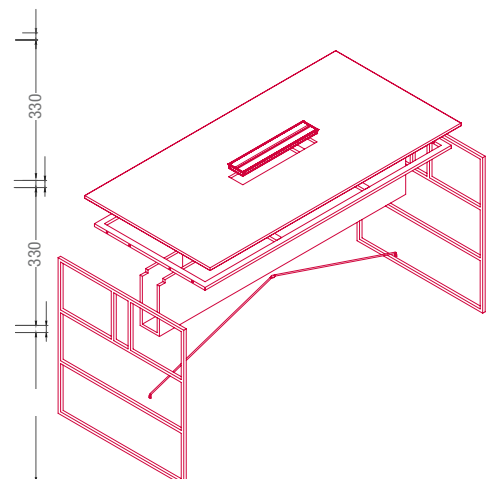
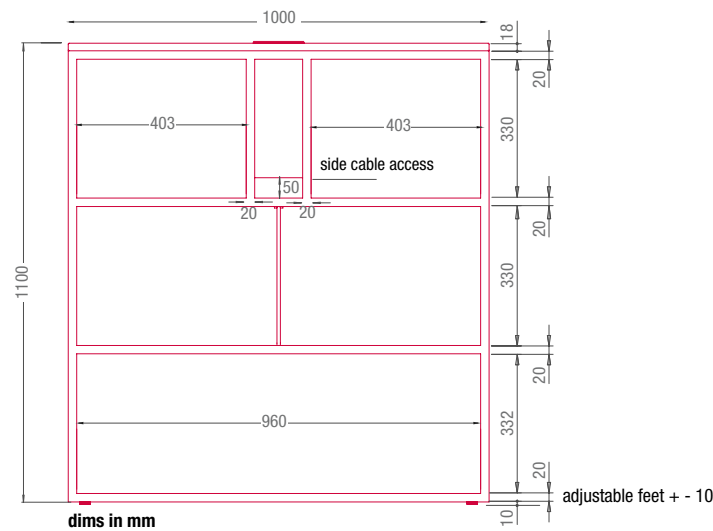

**HOW TO USE THE ACCESSORIES**

cable scheme and use of the internal cabinet without accessories

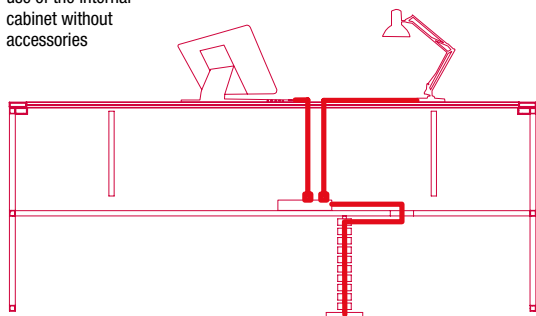

cable scheme and use of the accessories inside the internal cabinet

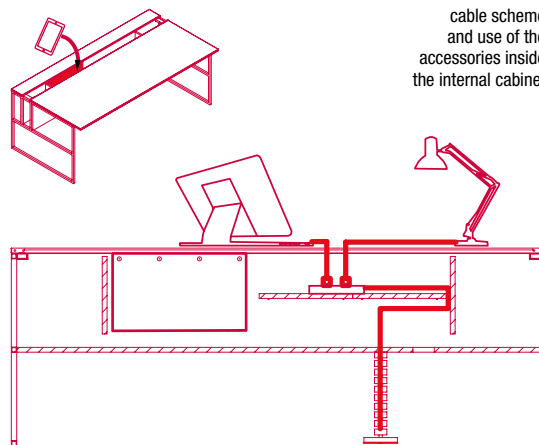

**SOUND-ABSORPTION SCREEN**

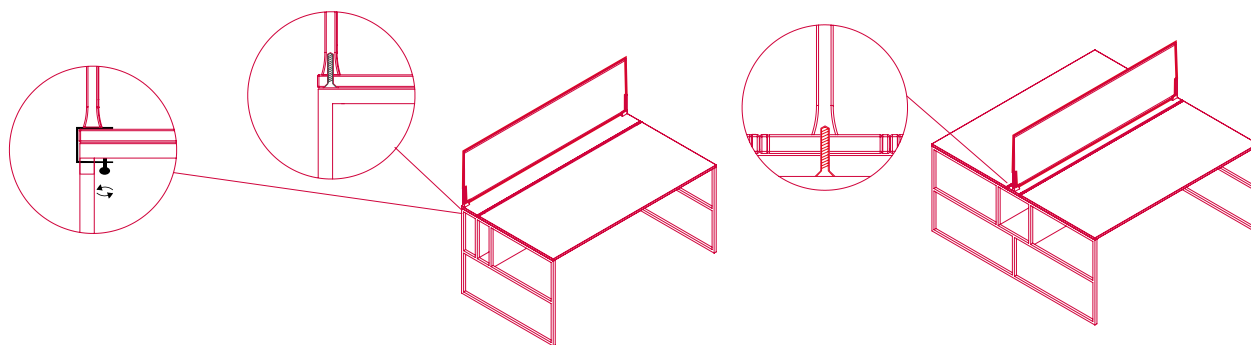

**OPEN COMPARTMENT**

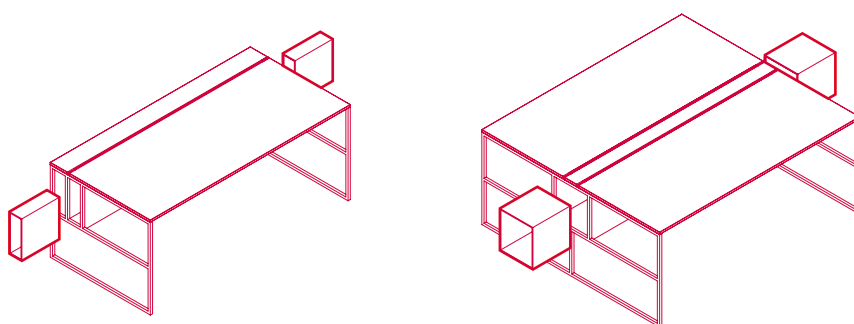

# Finishing

The number in the dot corresponds to the number of colour/material finish.

Here below, in the section FINISH OPTIONS, please note all the colours of the materials used for this product.

## SYSTEM

---

### Top



Fenix

### Structure

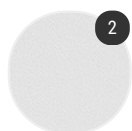

Matt painted

### Open compartment



Matt lacquered

## ACCESSORIES

---

### Structure

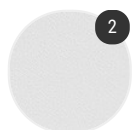

Matt painted

# Finish options

## TOP

---

### Fenix



Fenix matt  
white X020

Fenix matt  
light grey

Fenix matt  
medium grey  
X021

Fenix matt  
black X022

## STRUCTURE

---

### Matt painted

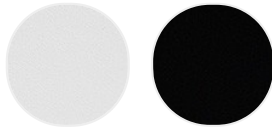

Matt painted  
white X053

Matt painted  
graphite grey  
X054

## OPEN COMPARTMENT

---

### Matt lacquered

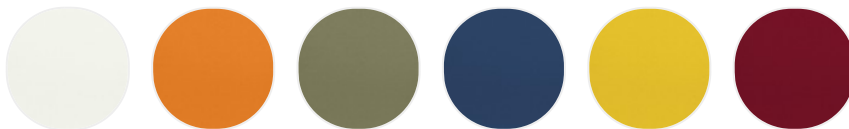

Matt painted  
white X042

Matt painted  
orange X047

Matt painted  
green X049

Matt painted  
avio blue  
X050

Matt painted  
mustard  
yellow X048

Matt painted  
dark red X046