

Ultra

design: AZ Creations

ULTRA è una famiglia di sedute operative adatte ad un utilizzo giornaliero continuativo; è una seduta che evoca una sensazione di leggerezza e semplicità, ma robustezza allo stesso tempo. È disponibile in versione con base e telaio cromato oppure con base in poliamide nero e telaio verniciato nero, adattabile perciò a diverse esigenze di arredamento. È possibile applicare braccioli regolabili; la versione attesa con base quattro gambe può essere dotata di agganci e di tavoletta.

ULTRA is a family of task office chairs suitable for continuous daily use; it is a chair that evokes a feeling of lightness and simplicity, but strength at the same time. It is available with chromed base and frame, or with black nylon base and black painted frame, therefore adapting to various requirements of furniture. It is possible to apply adjustable arms, the visitor version with 4-leg base can be equipped with linking device and writing tablet.

ULTRA est une famille de sièges opératifs aptes à un usage quotidien continu ; c'est un siège qui évoque une sensation de légèreté et simplicité et au même temps de robustesse. Ultra est disponible avec structure et piètement chromés, ou piètement en polyamide noir et structure époxy noir, ce qui lui permet de s'adapter à plusieurs exigences d'ameublement. C'est possible d'appliquer des accoudoirs réglables ; la version attente 4 pieds peut être équipée de système d'accrochage et tablette écriteire.

ULTRA ist eine Stuhlfamilie für einen täglichen dauerhaften Einsatz. Es handelt sich um einen Stuhl welcher Leichtigkeit und Einfachheit beschwört, aber gleichzeitig auch Stärke. Verfügbar mit verchromten Rahmengestell der Rückenlehne mit Alu Fußkreuz, oder mit schwarzem Polyamid Fußkreuz und schwarze pulverbeschichtete Rahmengestell der Rückenlehne welche sich für jede Anforderungen der Einrichtungen eignet. Es ist möglich verschiedene verstellbare Armlehnen anzuwenden. Der 4-Fu Besucherstuhl kann mit Verbindungssystem und Schreibplatte ausgestattet werden.



Ultra



Ultra

Girevole, schienale in rete, supporto lombare regolabile. Schienale nero o cromato.

Swivel, mesh backrest, adj. lumbar support. Black or chromed backrest.

Pivotant, dossier en resille, soutien lombaire régl. Dossier noir ou chrome.

Drehbar, Netz Rückenlehne, verstellbare Lumbalstütze. Rückenlehne schwarze oder verchromt.

versions



Ultra

Ultra



Ultra



Ultra



Ultra





technical data

mechanism

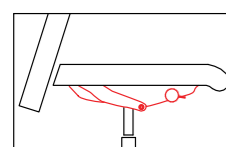

Meccanismo SynchroPlus+ con traslazione sedile
SynchroPlus+ mechanism with sliding seat device
SynchroPlus+ avec translation d'assise
SynchroPlus+ Mechanik mit Schiebesitz

base



Base 5 razze poliamide nera
5-spoke black polyamide base
Pièt. 5 branches polyam. noir
5-Stern schwarzes Polyamid Fußkreuz



Base 5 razze in alluminio lucida
5-spoke polished aluminium base
Pièt. 5 branches alu poli
5-Stern Alu poliertes Fußkreuz

castors

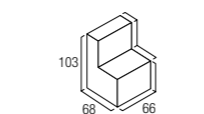
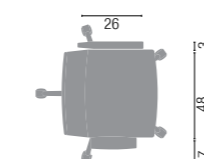
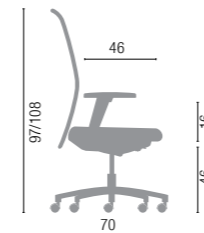

UNIT/PAK 1 - Kg 15,59 - m³ 0,4

1. SCHIENALE:

Schienale in tubo tondo d'acciaio, Ø 20mm, finitura cromata (15µm) o verniciata a polveri, rivestito in rete (poggiareni in poliamide imbottito e rivestito in tessuto)

2. SEDILE:

Sedile in polipropilene imbottito con spugna schiumata a freddo, rivestita in tessuto

3. MECCANISMO:

SynchroPlus+, comando elevazione a gas, regolazione tensione schienale, inclinazione 20°sch. 8°sed. in 5 posizioni con antishock, traslazione sed. 6cm in 5 posizioni

4. GAS:

- Regolabile in altezza, rotazione, finitura cromata
- Regolabile in altezza, rotazione, finitura nera

5. BASE:

- Base 5 razze in alluminio, Ø 700mm, finitura lucida
- Base 5 razze in poliamide con carica di fibra di vetro, Ø 680mm, finitura nero

6. RUOTE:

Ruote Ø 50mm, autofrenanti o autofrenanti e gommate, finitura nera

7. BRACCIOLI:

- Bracciolo regolabile in poliamide, finitura nera, con top in poliamide, finitura nera, o top in poliuretano morbido
- Bracciolo regolabile in 4D in tubo ovale d'acciaio, 45x25mm, finitura cromata, con top in poliuretano morbido
- Bracciolo regolabile in altezza in tubo ellittico d'acciaio, 40x20mm, finitura cromata (15µm) verniciata a polveri, con top in poliamide, finitura nera (tavoletta in polipropilene)
- Bracciolo regolabile in tubo ellittico d'acciaio, 40x20mm, finitura cromata (15µm) o verniciata a polveri, con top in poliamide, finitura nera, o top in poliuretano morbido

1. BACKREST:

Mesh backrest, Ø 20m steel tube structure, Chromed Finish (15µm) or powder coated, (polyamide lumbar support padded and upholstered)

2. SEAT:

polypropylene seat, cold injected foam padded, fabric upholstery

3. MECHANISM:

SynchroPlus+, gas lift height adj. Backrest tension adj. backrest inclination 20° in 5 locking position with antishock, seat inclination 8°. Sliding seat device 6cm in 5 positions

4. GAS LIFT:

- Height adjustable, swivel, chromed finish
- Height adjustable, swivel, Black finish

5. BASE:

- Polished aluminium 5 spoke base, Ø 700 mm
- Fiberglass reinforced polyamide 5 spoke base, Ø 680 mm, black finish

6. CASTORS:

Ø 50 mm self-braking castors, or soft self-bracking. Black finish



1. DOSSIER:

Dossier en tube d'acier rond, Ø 20mm, finition chromé (15µm) ou verni époxy, revêtu en résille (soutien lombaire en polyamide rembourré et tapissé)

2. ASSISE:

Assise en polypropylène rembourrée de mousse moulée à froids, tapissée

3. MECANISME:

SynchroPlus+, réglage en hauteur, réglage de tension, inclinaison dossier 20°et assise 8°, en 5 positions avec système anti-choc, profondeur d'assise 6 cm en 5 positions

4. VERIN A GAZ:

- Réglable en hauteur, pivotant, finition chromé
- Réglable en hauteur, pivotant, finition noir

5. PIÈTEMENT:

- Piètement 5 branches alu poli, Ø 700mm
- Piètement 5 branches en polyamide renforcé en fibre de verre, Ø 680mm, finition noir

6. ROULETTES:

Roulettes Ø 50mm, autofreinantes ou autofreinantes et gommées, finition noir

7. ACCUDOIR:

- Accoudoir réglable en polyamide, finition noir, manchette en polyamide, finition noir ou en polyuréthane souple
- Accoudoir réglable en 4D en tube ovale d'acier, 45x25mm, finition chromé, manchette en polyuréthane souple
- Accoudoir réglable en hauteur en tube d'acier elliptique, 40x20mm, finition chromé (15µm) ou verni époxy, manchette en polyamide, finition noir
- Accoudoir réglable en tube d'acier elliptique, 40x20mm, finition chromé (15µm) ou verni époxy, manchette en polyamide, finition noir ou en polyuréthane souple

1. RÜCKENLEHNE:

Netz Rückenlehne, Ø20 Stahlrohrrahmen, verchromt (15 µm) oder pulverbeschichtet. (ausgepolstert Polyamid Lumbalstütze mit Stoffbezug)

2. SITZ:

Polypropylen Sitz, ausgepolstert mit kaltgeschäumten Polyurethan, mit Stoffbezug

3. MECHANIK:

SynchroPlus+, Gaslift Höhenverstellung, Rückenlehne mit Spannungsregler, 20° Rückenlehneigung, 8° Sitzneigung, 5-stufige Einstellung mit Antishock, 6 cm Sitztiefeverstellung mit 5 Positionen

4. GASFEDER:

- Sitzhöhenverstellung, drehbar, verchromt
- Sitzhöhenverstellung, drehbar, schwarz

5. GESTELL:

- 5-Stern Alu poliertes Fußkreuz, Ø 700 mm
- 5-Stern schwarzes glasfaserverstärktes Polyamid Fußkreuz, Ø 680 mm

6. ROLLEN:

Ø 50 mm gebremste, oder weiche gebremste Rollen, schwarz

7. ARMLEHNEN:

- Verstellbare schwarze Polyamid Armlehne mit Polyamid Armauflage oder mit weiche Polyurethan Armauflage
- 4D verstellbare Armlehne aus ovales Stahlrohr, 45x25mm, verchromt (15µm) schwarze Polyamid weiche Armauflage
- Höhenverstellbare Armlehne aus Ellipt. Stahlrohr, 40x20 mm, verchromt (15 µm) oder pulverbeschichtet, schwarze Polyamid Armauflage (Ablageplatte aus Polypropylen)
- Verstellbare Armlehne aus Ellipt. Stahlrohr, 40x20mm, verchromt (15µm) oder pulverbeschichtet, schwarze Polyamid Armauflage oder weichen Polyurethan



Ultra

options

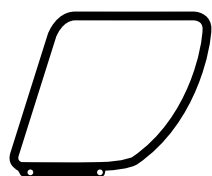

XB019 - fixed
polyamide

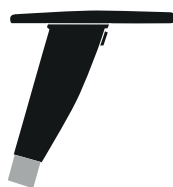

XB018 - chromed 2D

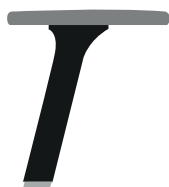

XB024 - chromed
4D soft pad

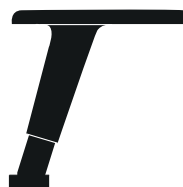

XB020 - 2D
XB021 - 3D

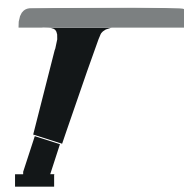

XB022 - 2D soft pad
XB023 - 3D soft pad



XB025 - chromed
2D soft pad
XB084 - chromed
3D soft pad

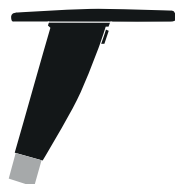

XB082 - chromed 3D



XB046 - height
adj.

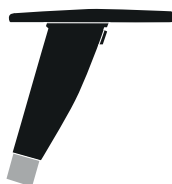

XB017 - chromed
height adj.



XD001 - seat with
springs

Ultra

4-legs castors



Ultra

Fissa, schienale in rete, struttura in metallo. Schienale nero o cromato.

Visitor, mesh backrest, metal structure. Black or chromed backrest.

Visiteur, dossier en résille, structure en métal. Dossier noir ou chromé.

Besucher, Netz Rückenlehne, Metallgestell. Schwarze oder verchromt Rückenlehne.

versions

Ultra
4-legs



Ultra
4-legs castors

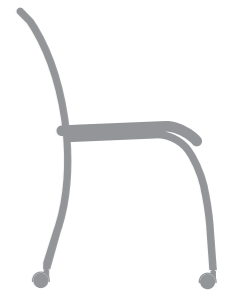



Ultra

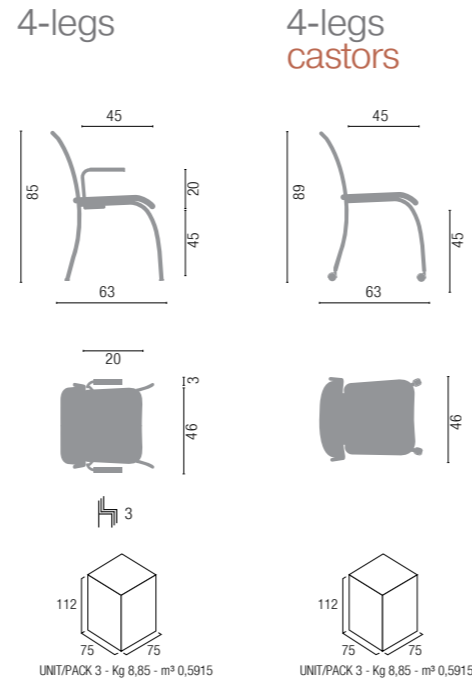

technical data

options

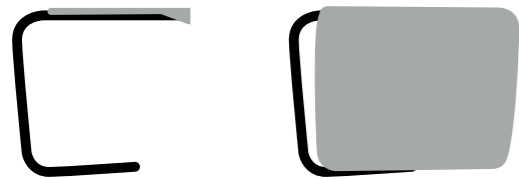

XB044 - chromed
XB045 - black

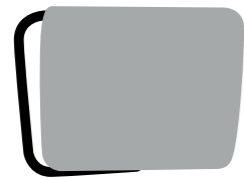

XS003 - writing tablet

base



Base 4 gambe cromata, vern. grigia o nera
4-legs chromed, grey or black painted base
Pièd. 4 pieds chromé, verni gris ou noir
4-Fuß Gestell verchromt, grau oder schwarz pulverb

feet/castors



Base 4 gambe con ruote cromata, vern. grigia o nera
4-legs chromed, grey or black painted base, on castors
Pièd. 4 pieds chromé, verni gris ou noir, sur roulettes
4-Fuß Gestell verchromt, mit Rollen, grau oder schwarz pulverb

Ultra



1. SCHIENALE:

Schienale in tubo d'acciaio integrato alla base, rivestito in rete

2. SEDILE:

Sedile in polipropilene imbottito con spugna, rivestita in tessuto

3. BASE:

Base 4 gambe in tubo d'acciaio Ø 22mm, finitura cromata (15µm) o verniciata a polveri

4. RUOTE/PIEDINI:

- Tappi in polipropilene, finitura nera
- Ruote Ø 50mm, autofrenanti o autofrenanti e gommate, finitura nera

5. BRACCIOLI:

Bracciolo fisso in tubo tondo d'acciaio, Ø 16mm, finitura cromata (15µm) o verniciata a polveri, con top in poliamide, finitura nera

1. BACKREST:

Mesh backrest, steel tube structure

2. SEAT:

polypropylene seat, foam padded, fabric upholstery

3. BASE:

4 legs base, Ø 22 mm steel tube, chromed finish (15µm) or powder coated

4. CASTORS/FEET:

- polypropylene plugs, black finish
- Ø 50 mm self-braking castors, or soft self-bracking. Black finish

5. ARMREST:

Fixed armrest, round steel tube, Ø16mm, chromed finish (15µm), or powder coated, polyamide top pad, black finish

1. DOSSIER:

Dossier en tube d'acier intégré à la structure, en résille

2. ASSISE:

Assise en polypropylène rembourrée de mousse, tapissée

3. PIÈTEMENT:

Piètement 4 pieds en tube d'acier Ø 22mm, finition chromé (15µm) ou verni époxy

4. ROULETTES/PATINS:

- Tampons en polypropylène, finition noir
- Roulettes Ø 50mm, autofreinantes ou autofreinantes et gommées, finition noir

5. ACCOUDOIR:

Accoudoir fixe en tube rond d'acier, Ø 16mm, finition chromé (15µm) ou verni époxy, manchette en polyamide, finition noir

1. RÜCKENLEHNE:

Netz Rückenlehne, Stahlrohrrahmen

2. SITZ:

Polypropylen Sitz, ausgepolstert mit Polyurethan schaum, mit Stoffbezug

3. GESTELL:

4-Fuß Gestell, Ø 22mm Stahlrohr, verchromt (15µm) oder pulverbeschichtet

4. ROLLEN/GLEITER:

- Polyamid Gleiter, schwarz
- Ø 50 mm gebremste, oder weiche gebremste Rollen, schwarz

5. ARMLEHNE:

Feste Armlehne aus Stahlrohr, Ø 16 mm, verchromt (15 µm) oder pulverbeschichtet, schwarze Polyamid Armauflage

